



Software : by Martin J. King  
e-mail MJKing57@aol.com

Copyright 2011 by Martin J. King. All Rights Reserved.

Configuration : Extended Range Driver w/ Two Bass Drivers Mounted on an Open Baffle

**Unit and Constant Definition**

cycle := 2·π·rad

Hz := cycle·sec<sup>-1</sup>

Air Density : ρ := 1.205·kg·m<sup>-3</sup>

Speed of Sound : c := 344·m·sec<sup>-1</sup>



**Part 1 : Thiele-Small Consistent Calculation**

**Detailed User Input** (Edit This Section and Input the Parameters for the System to be Analyzed)

Power := 1·watt (Input Power) Applied Voltage Reference ---> R<sub>ref</sub> := 8·Ω

Extended Range Driver Thiele / Small Parameters : Fostex FE-167E

f<sub>d</sub> := 51.5·Hz V<sub>ad</sub> := 35.94·liter

R<sub>e</sub> := 7.1·Ω Q<sub>ed</sub> := 0.33

L<sub>vc</sub> := 0.0·mH Q<sub>md</sub> := 4.63

Bl := 6.82· $\frac{\text{newton}}{\text{amp}}$  Q<sub>td</sub> :=  $\left(\frac{1}{Q_{ed}} + \frac{1}{Q_{md}}\right)^{-1}$

S<sub>d</sub> := 132.7·cm<sup>2</sup> Q<sub>td</sub> = 0.308



Bass Driver Thiele / Small Parameters : Eminence Alpha 15" High Efficiency

f<sub>d</sub> := 41·Hz V<sub>ad</sub> := 260·liter

R<sub>e</sub> := 5.88·Ω Q<sub>ed</sub> := 1.53

L<sub>vc</sub> := 0.84·mH Q<sub>md</sub> := 7.23

Bl := 7.7· $\frac{\text{newton}}{\text{amp}}$  Q<sub>td</sub> :=  $\left(\frac{1}{Q_{ed}} + \frac{1}{Q_{md}}\right)^{-1}$

S<sub>d</sub> := 856.3·cm<sup>2</sup> Q<sub>td</sub> = 1.263



## Instructions :

1. If a Zobel is used, set  $L_{vc}$  equal to zero in driver inputs above. If no Zobel is used, enter a value for  $L_{vc}$ .
2. Select the crossover frequencies, orders, and types below.
3. Scroll down to the applicable crossover sections below and fill in the values of the circuit components.
  - a. The theoretical values are shown to the right of each schematic.
  - b. Theoretical values are calculated using only the driver's DC resistance, a textbook solution.
  - c. Enter the actual component values, these should correspond to available components.
  - d. Iterate the actual component values to optimize the crossover responses.
  - e. You can mix the crossover orders and types by using only half of each pair of schematics.
4. Purchase the optimized actual component values and construct the crossover per the schematics.

## Crossover Definition

For Even Order Crossovers :  
Type 1 = Linkwitz-Riley  
Type 2 = Bessel  
Type 3 = BEC  
Type 4 = Butterworth

### Low Pass Filter

$$f_{LP} := 200 \cdot \text{Hz}$$

$$LP_{order} := 2$$

$$LP_{type} := 1$$

### High Pass Filter

$$f_{HP} := 300 \cdot \text{Hz}$$

$$HP_{order} := 2$$

$$HP_{type} := 1$$

(Filter Frequency)

(Filter Order : 0, 1, 2, 3, or 4)

(Filter Type : 1, 2, 3, or 4 for even order only,  
for odd order this entry is ignored)

### Crossover Phase Connection

$$LP_{phase} := 1$$

$$HP_{phase} := 1$$

(1 = in phase, -1 = out of phase)

## Crossover Definition - 1<sup>st</sup> Order High and Low Pass



### Schematic

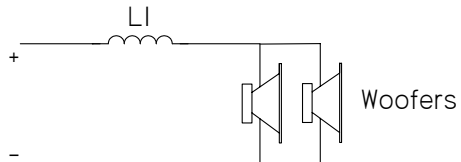
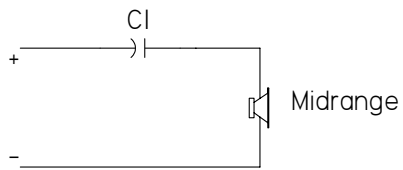

### Theoretical Values

$$C_1 = 74.721 \mu\text{F}$$

$$L_1 = 2.340 \text{ mH}$$

Enter Actual Component Values Below

High Pass

$$C_1 := 75 \cdot \mu\text{F}$$

Low Pass

$$L_1 := 2.35 \cdot \text{mH} \quad R_1 := 0.1 \cdot \Omega$$



## Crossover Definition - 2<sup>nd</sup> Order High and Low Pass



### Schematic

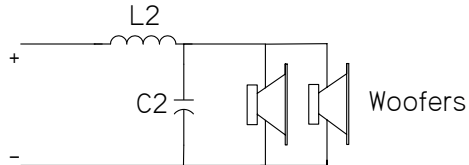
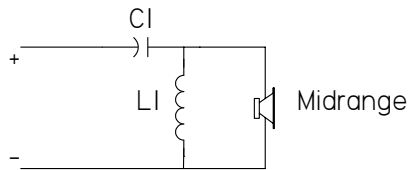

### Theoretical Values

$$C_1 = 37.360 \mu\text{F}$$

$$L_1 = 7.533 \text{ mH}$$

$$L_2 = 4.679 \text{ mH}$$

$$C_2 = 135.336 \mu\text{F}$$

### Enter Actual Component Values Below

#### High Pass

$$C_1 := 37 \cdot \mu\text{F}$$

$$L_1 := 7.5 \cdot \text{mH} \quad R_1 := 0.4 \cdot \Omega$$

#### Low Pass

$$L_2 := 4.5 \cdot \text{mH} \quad R_2 := 0.3 \cdot \Omega$$

$$C_2 := 135 \cdot \mu\text{F}$$



## Crossover Definition - 3<sup>rd</sup> Order High and Low Pass



### Schematic

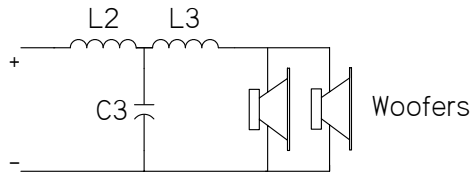
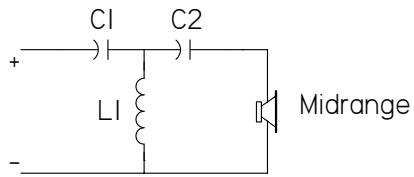

### Theoretical Values

$$C_1 = 49.814 \mu\text{F}$$

$$L_1 = 2.825 \text{ mH}$$

$$C_2 = 149.441 \mu\text{F}$$

$$L_2 = 3.509 \text{ mH}$$

$$C_3 = 360.896 \mu\text{F}$$

$$L_3 = 1.170 \text{ mH}$$

Enter Actual Component Values Below

### High Pass

$$C_1 := 50 \cdot \mu\text{F}$$

$$L_1 := 3 \cdot \text{mH} \quad R_1 := 0.3 \cdot \Omega$$

$$C_2 := 150 \cdot \mu\text{F}$$

### Low Pass

$$L_2 := 3.5 \cdot \text{mH} \quad R_2 := 0.3 \cdot \Omega$$

$$C_3 := 360 \cdot \mu\text{F}$$

$$L_3 := 1 \cdot \text{mH} \quad R_3 := 0.2 \cdot \Omega$$



## Crossover Definition - 4<sup>th</sup> Order High and Low Pass



### Schematic

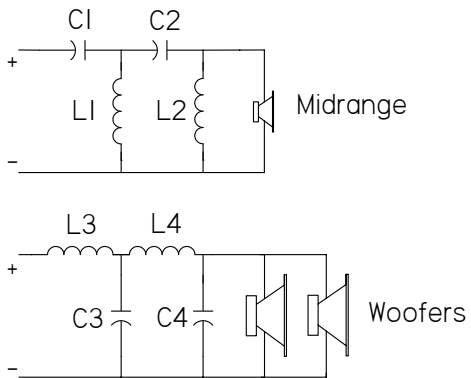

### Theoretical Values

$$C_1 = 39.624 \mu\text{F}$$

$$L_1 = 2.367 \text{ mH}$$

$$C_2 = 79.249 \mu\text{F}$$

$$L_2 = 10.652 \text{ mH}$$

$$L_3 = 4.410 \text{ mH}$$

$$C_3 = 430.782 \mu\text{F}$$

$$L_4 = 2.205 \text{ mH}$$

$$C_4 = 95.748 \mu\text{F}$$

Enter Actual Component Values Below

### High Pass

$$C_1 := 40 \cdot \mu\text{F}$$

$$L_1 := 2.5 \cdot \text{mH} \quad R_1 := 0.2 \cdot \Omega$$

$$C_2 := 80 \cdot \mu\text{F}$$

$$L_2 := 10 \cdot \text{mH} \quad R_2 := 0.5 \cdot \Omega$$

### Low Pass

$$L_3 := 4.5 \cdot \text{mH} \quad R_3 := 0.3 \cdot \Omega$$

$$C_3 := 450 \cdot \mu\text{F}$$

$$L_4 := 2.0 \cdot \text{mH} \quad R_4 := 0.1 \cdot \Omega$$

$$C_4 := 100 \cdot \mu\text{F}$$



End of Detailed Input

End of Part 1 Input

## OB Driver Impedance

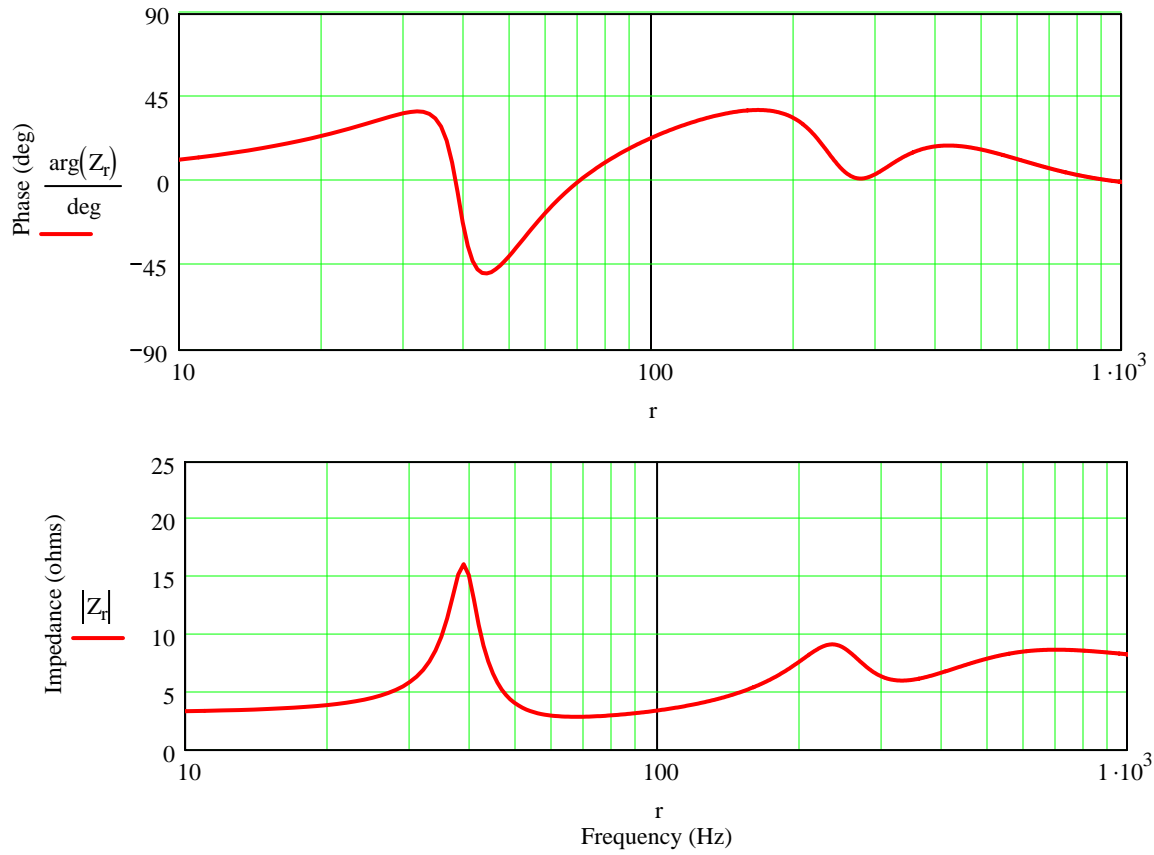

## Driver RMS Displacements (Red Curve - Woofers, Blue Curve - Extended Range Driver)

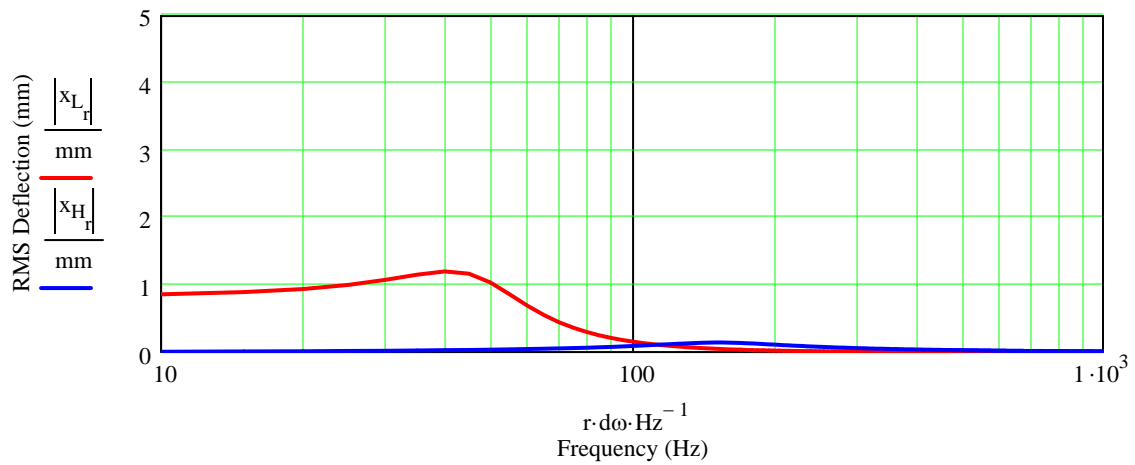

## Part 2 : Detailed SPL Response Calculation

Calculation Includes :

- Position of Drivers on the Baffle.
- Open Baffle Defraction for the Drivers.
- Floor Reflection for the Drivers.

### Geometry

Coordinate System :

- Origin is the lower left corner of the front baffle
- y = horizontal direction
- z = vertical direction

The variables num\_r, n\_low, and n\_high control the number of simple sources used in the calculations. Increasing each will improve accuracy at the expense of longer calculation times. Increase each variable until final plotted SPL stops changing at which point the solution has converged.

### Enclosure Geometry Input

- $X_0 := 2 \cdot \text{ft}$  (Front Baffle Distance from Rear Wall > Depth of Enclosure)
- $Y_0 := 1.5 \cdot \text{ft}$  (Front Baffle Distance from Side Wall)
- $\theta_0 := 45 \cdot \text{deg}$  (Rotation Towards Room Center)
- $Z_0 := 8 \cdot \text{ft}$  (Floor to Ceiling Distance)
- stand := 0·m (Height from Floor to Bottom Edge of Front Baffle)
- num\_r := 10 (Number of Points per Unit Length of Baffle Edge)

### Corner Coordinates

- | X coordinate                    | Y coordinate                    |                       |
|---------------------------------|---------------------------------|-----------------------|
| $y_{o_0} := 20 \cdot \text{in}$ |                                 | (Bottom Right Corner) |
| $y_{o_1} := 20 \cdot \text{in}$ | $z_{o_1} := 40 \cdot \text{in}$ | (Top Right Corner)    |
| $y_{o_2} := 0 \cdot \text{in}$  | $z_{o_2} := 40 \cdot \text{in}$ | (Top Left Corner)     |
| $y_{o_3} := 0 \cdot \text{in}$  |                                 | (Bottom Left Corner)  |

### Extended Range Driver Geometry Input

- $y_{dc} := 8 \cdot \text{in}$  (Driver Center y Coordinate)
- $z_{dc} := 34 \cdot \text{in}$  (Driver Center z Coordinate)
- n\_high := 5 (Number of Points Across Diameter)

### Woofers Driver Geometry Input

- $y_{w1} := 10 \cdot \text{in}$  (Lower Driver Center y Coordinate)
- $z_{w1} := 8 \cdot \text{in}$  (Lower Driver Center z Coordinate)
- $y_{w2} := 10 \cdot \text{in}$  (Upper Driver Center y Coordinate)
- $z_{w2} := 22 \cdot \text{in}$  (Upper Driver Center z Coordinate)
- n\_low := 10 (Number of Points Across Diameter)

**Listening Position** (Default Location is at 1 m Distance Along the Driver's Axis)

$n\_listen = 0$  (Listening Position Relative to Speaker)  
 $radius := 1 \cdot m$  (Calculation Radius, Effective Radius is Greater if  $y_p$  is Changed from Default)  
 $\theta := 0 \cdot deg$  (0 deg is along the Driver's Axis,  $-80 \text{ deg} < \theta < 80 \text{ deg}$ )  
 $z_p := z_{dc}$  (Default Height is Equal to Driver Height)

$n\_listen = 1$  (Listening Position Relative to the Room Corner)  
 $X_p := 10ft$   
 $Y_p := 7 \cdot ft$   
 $Z_p := z_{dc} + stand$  (Default Height is Equal to Driver Height)  
 $n\_listen := 0$  (Method Selection)

**Floor Condition**

$Reflect := 1$  (0 = hardwood or concrete, 1 = carpeted)

**Reflective Surface Selections** (if 1 reflective surface is included, if 0 reflective surface is removed)

$Inc\_floor := 1$  (Floor,  $Z = 0$ )  
 $Inc\_rear := 0$  (Rear Wall,  $X = 0$ )  
 $Inc\_side := 0$  (Left Side Wall,  $Y = 0$ )  
 $Inc\_ceiling := 0$  (Ceiling)



### Extended Range Driver and Two Woofers : Simple Source Pattern with Baffle Edge Outline

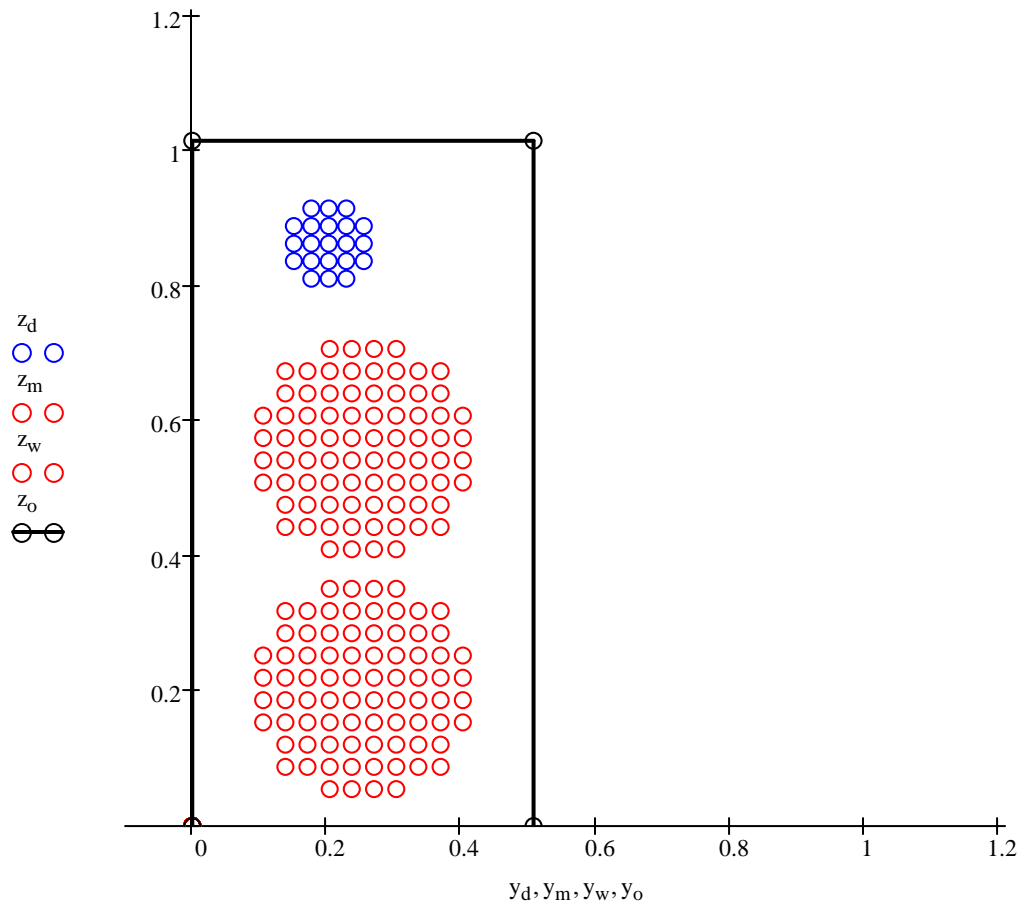



### Three Dimensional View

Axis Length (m) axis := 2 <---- Change value of "axis" to rescale plots

Room Corner is the Origin

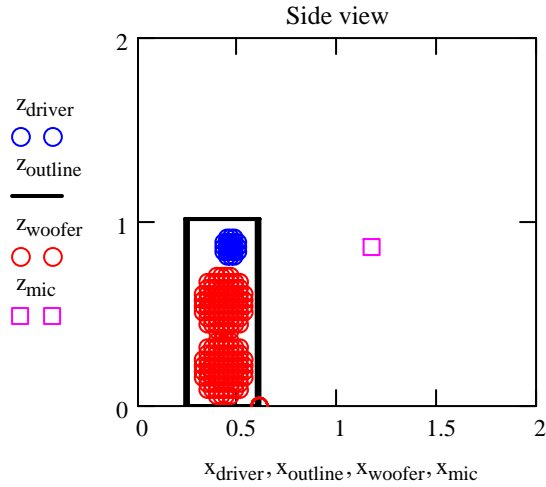

Side View - looking out from side wall

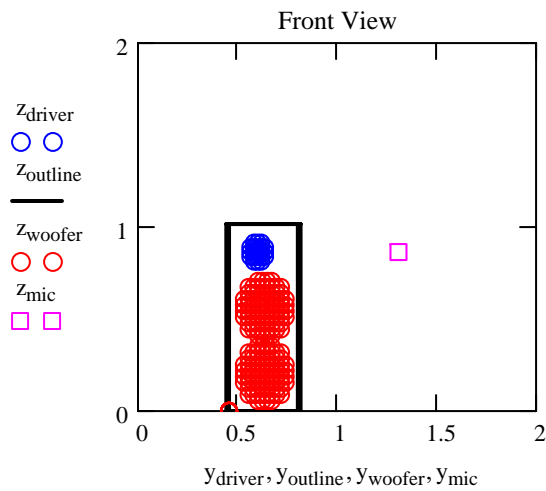

Front View - looking towards rear wall

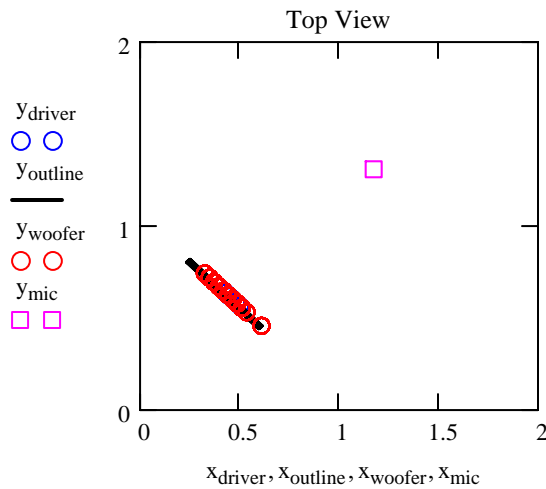

Top View - looking down from ceiling



## Plotted Response for the Extended Range Driver

- Dashed Red - Infinite Baffle Response
- Dashed Magenta - Baffle Response
- Dashed Brown - Crossover Response
- Solid Red - Combined Response

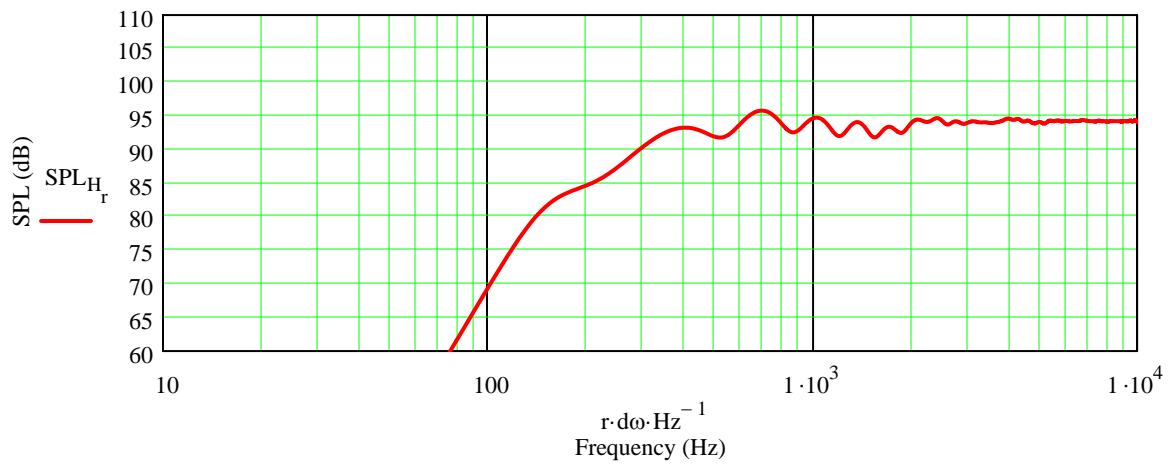
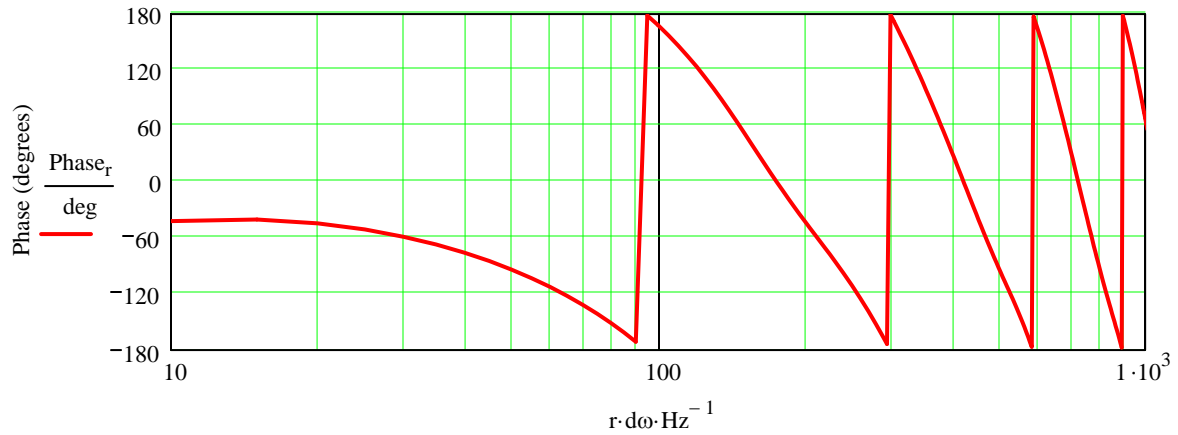
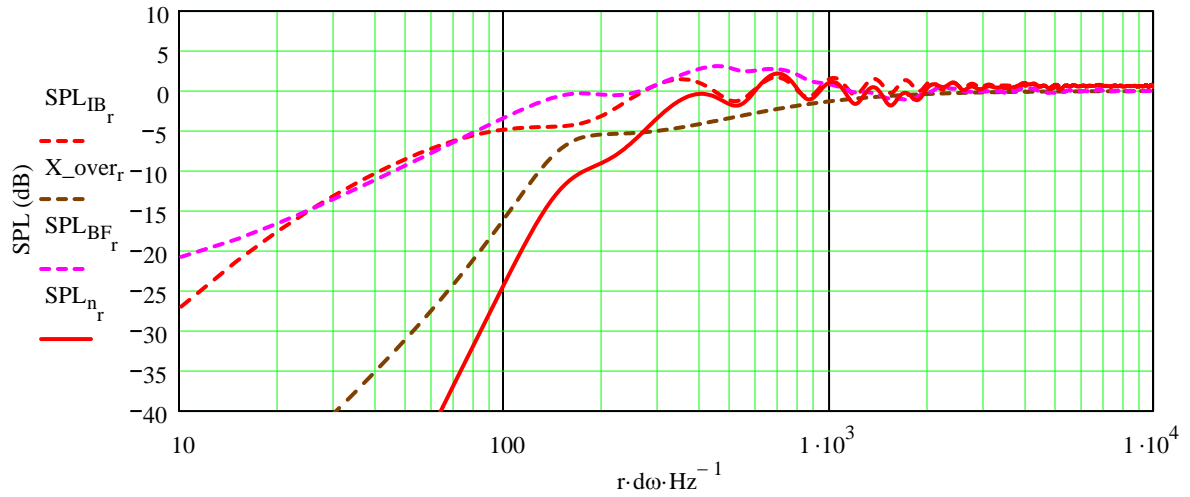

### Plotted Response for the Lower Woofer Driver

- Dashed Red - Infinite Baffle Response
- Dashed Magenta - Baffle Response
- Dashed Brown - Crossover Response
- Solid Red - Combined Response

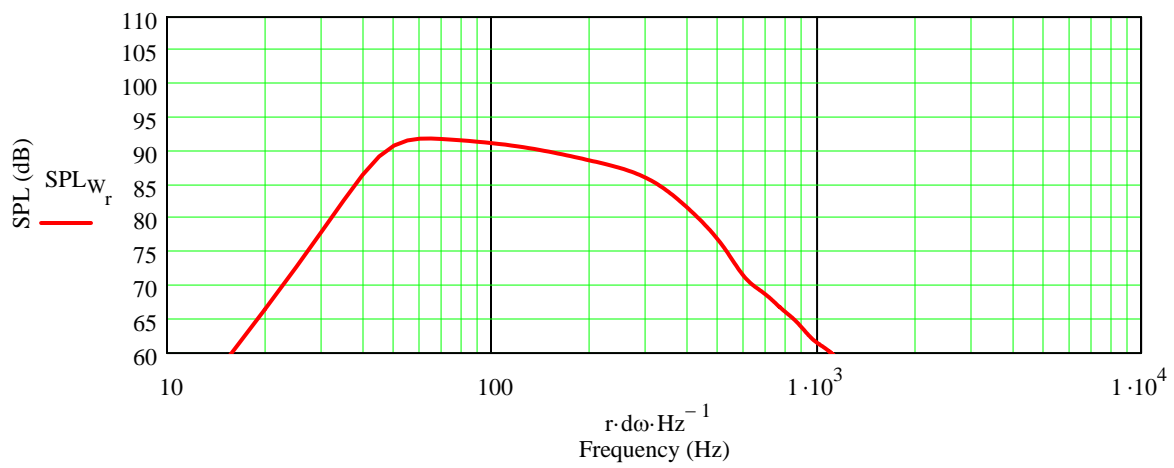
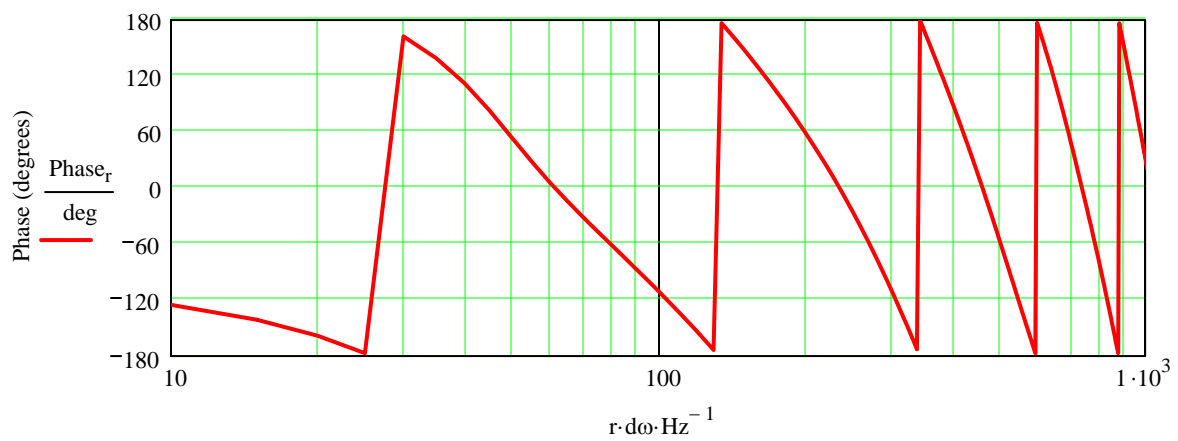
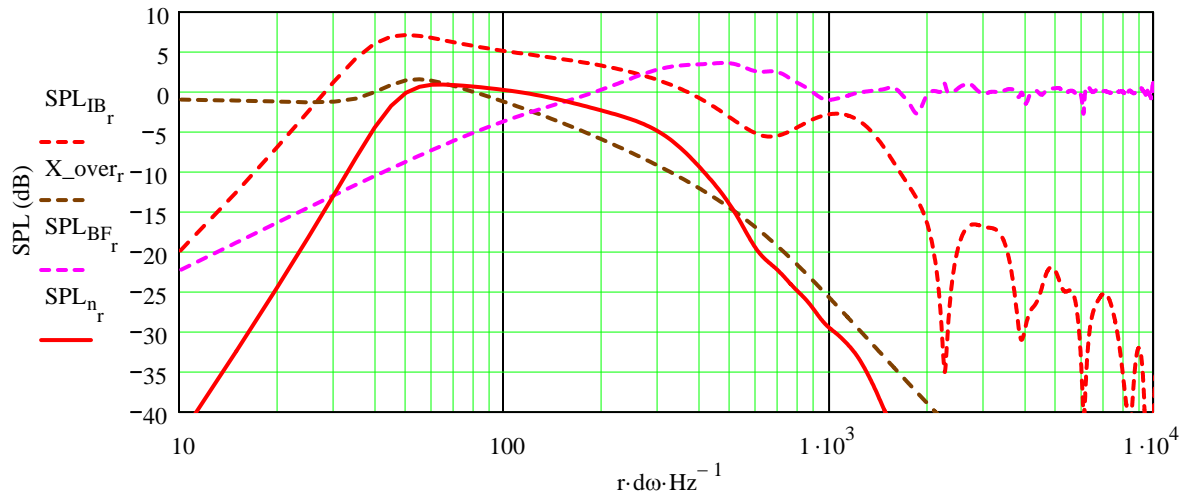

### Plotted Response for the Upper Woofer Driver

Dashed Red - Infinite Baffle Response  
 Dashed Magenta - Baffle Response  
 Dashed Brown - Crossover Response  
 Solid Red - Combined Response

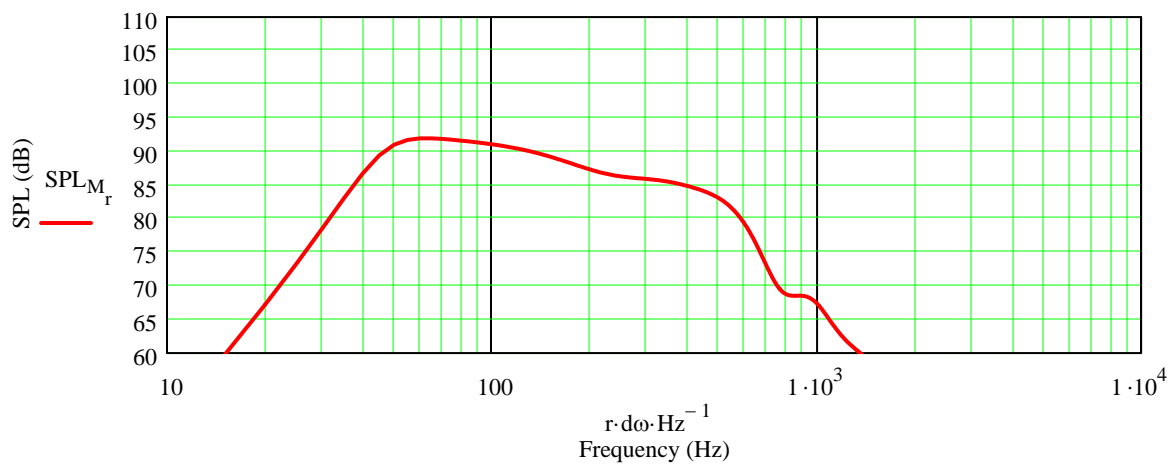
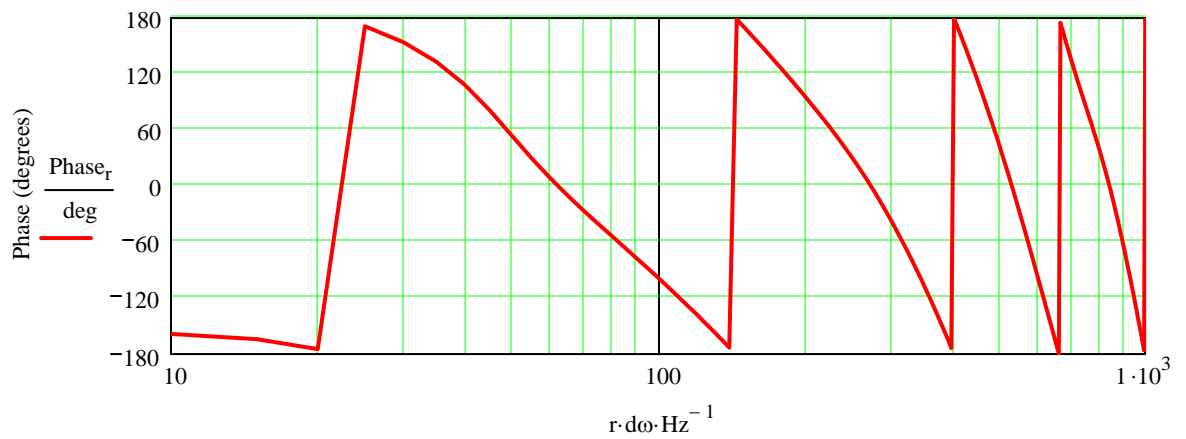
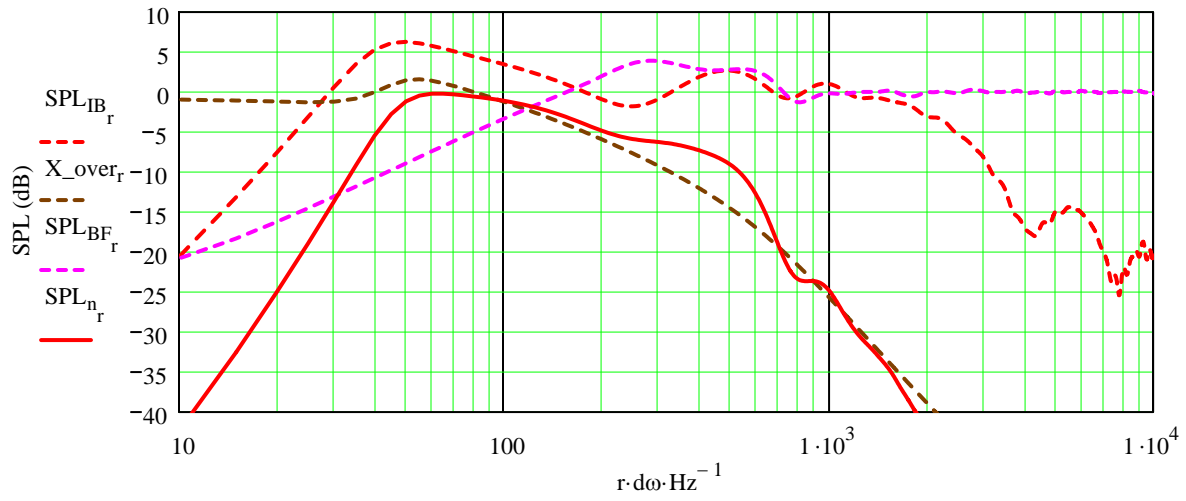

### Plotted Combined Response for the Woofer Drivers

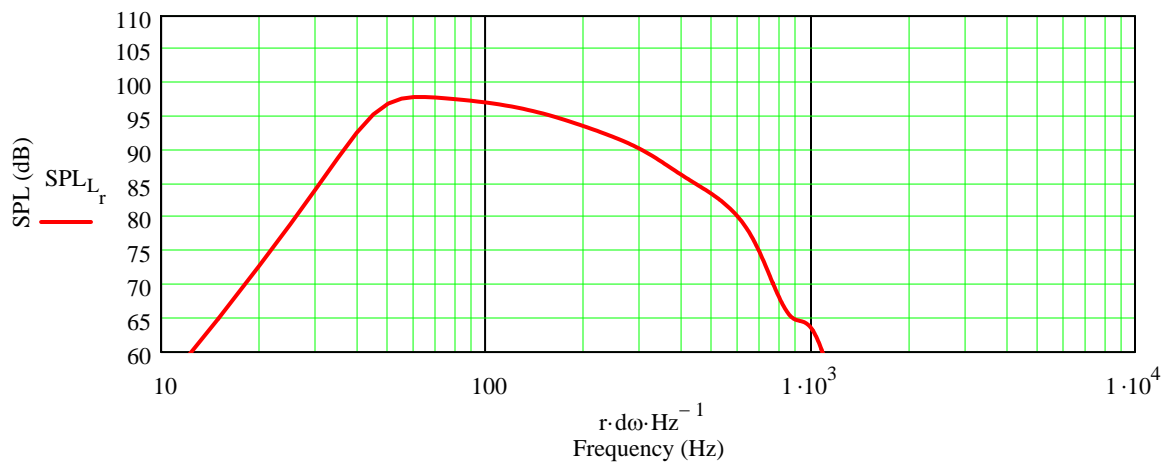
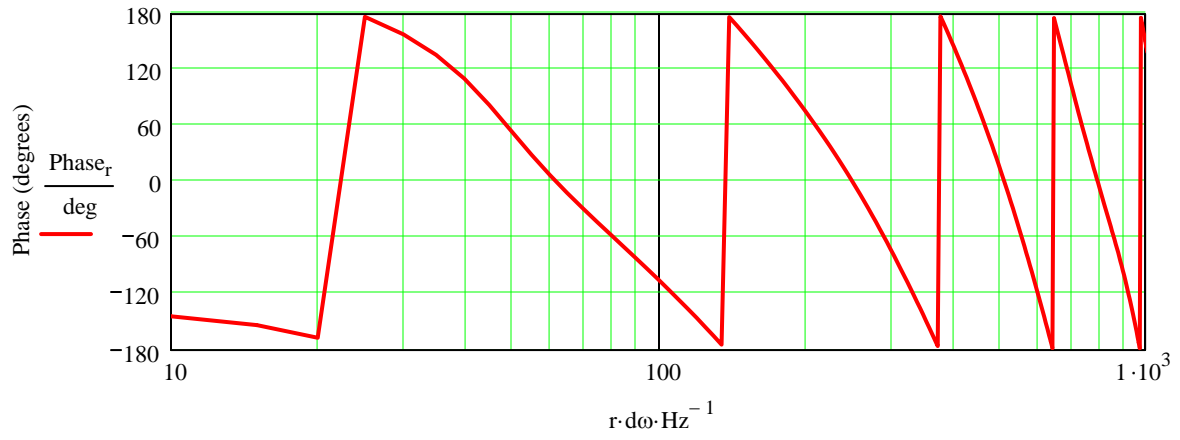

### Plotted System Response for the Extended Range/Dual Woofer Open Baffle Design

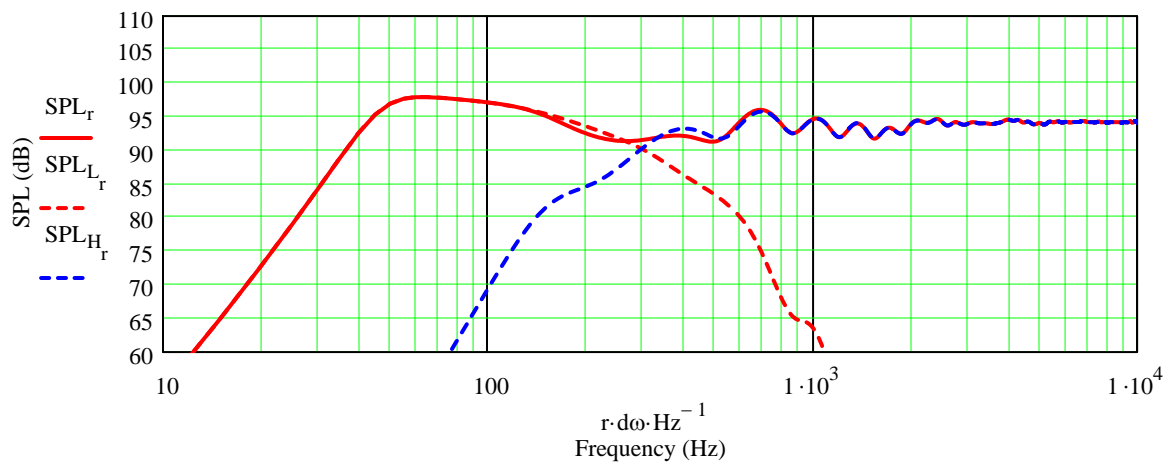
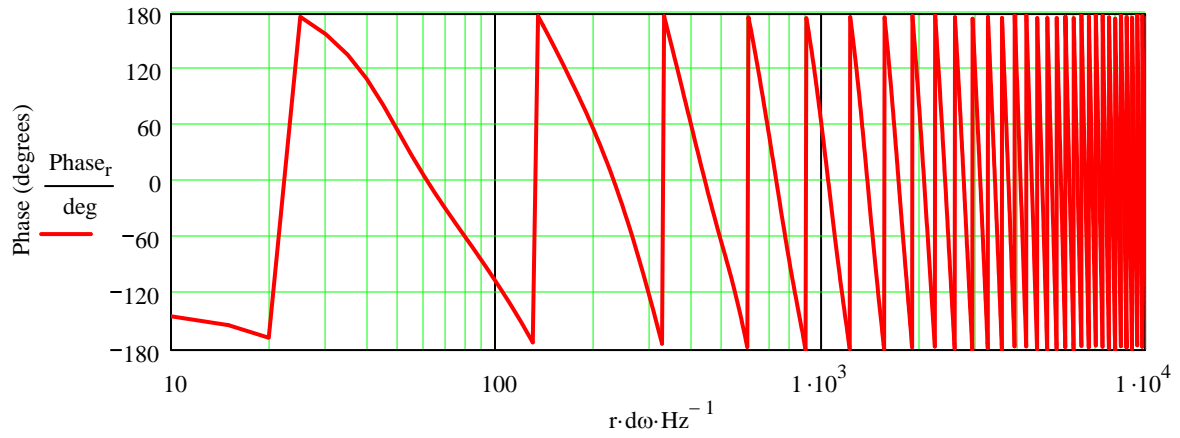

## System Time Response for an Impulse Input

